

CNC CAT

low cost... high quality...

Spindle 3.0KW ATC

RTM100-30-24Z 3.0 220V



Catalog

1. Product overview	2
2. Product appearance figure	2
3. Product characteristic curve graph	3
4. Product technical parameter table	4
5. Spindle installation explanation	5-7
1) Circulation cooling system instructions.....	5
2) Air seal (AS).....	5
3) Compressed gas air quality requirements.....	5
4) Running-in program instructions.....	5
5) Product backend interface explanation.....	5-6
6) Product locking and unlocking tool signal instructions.....	6
7) Thermistor parameters.....	7
8) Product rear end gas line explanation.....	7
6. Products using precautions	8
1) Product installed process precautions.....	8
2) Maintain maintenance precautions.....	8
7. Product common malfunctions&method of exclusion	9

1. Product overview

1) This spindle is built-in type spindle motor, built-in three asynchronous motors, by the inverter control. As the spindle has a compact structure, high power, big torque, small vibration, low noise characteristics, so it can achieve high speed, high power cutting, high precision and high stability operation.

2) The bearing of spindle use grease lubricated angular to contact bearings, can be achieved lifelong lubricating within the life cycle.

3) The spindle use forced cooling mode to cooling motor, front and rear bearings. Coolant flow through the reasonable arrangement cycle watercourse of the spindle body, thus can take the heat generated of the spindle rotation speed, to achieve thermal equilibrium, let spindle temperature within a certain constant value. External cooling device effect: maintaining a constant temperature of the coolant.

4) The spindle built-in PTC 140 temperature sensor (Technical parameters are visible in other sections of this specification), you can read it anytime if you need to protect the motor temperature.

5) The tool clamping methods: this spindle built-in automatic tool change device, shank form is BT30.

2. Product appearance figure

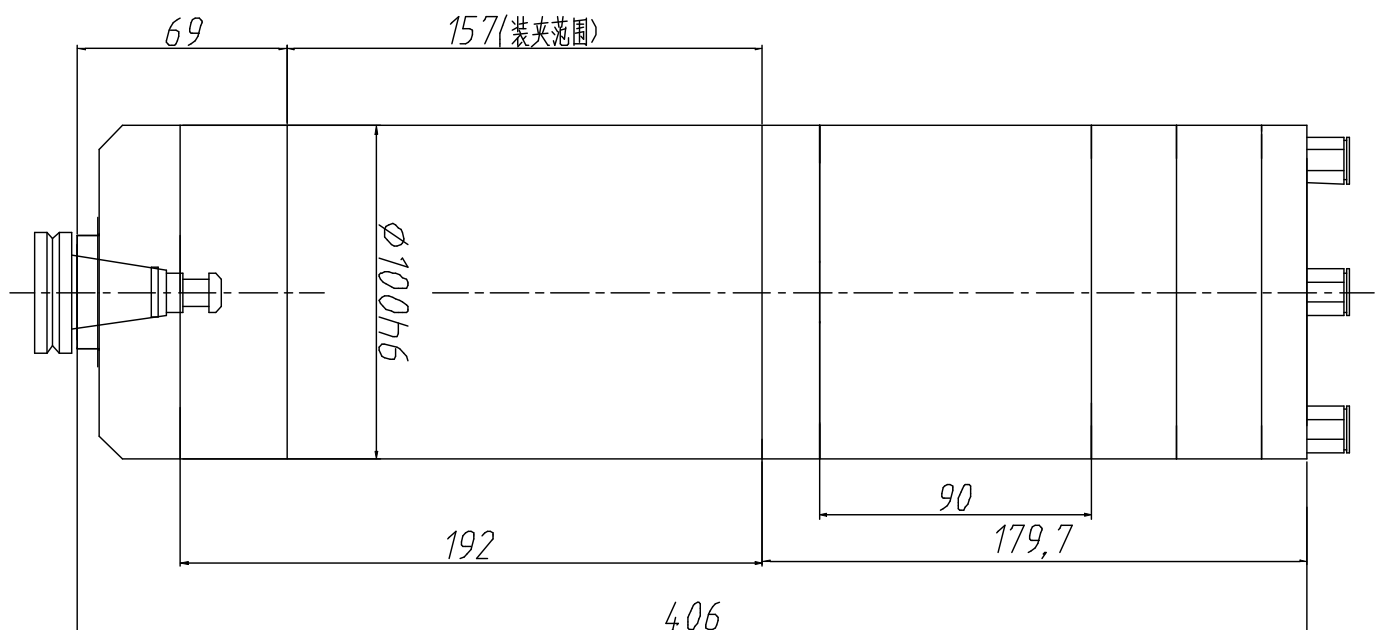

3. Product characteristic curve graph

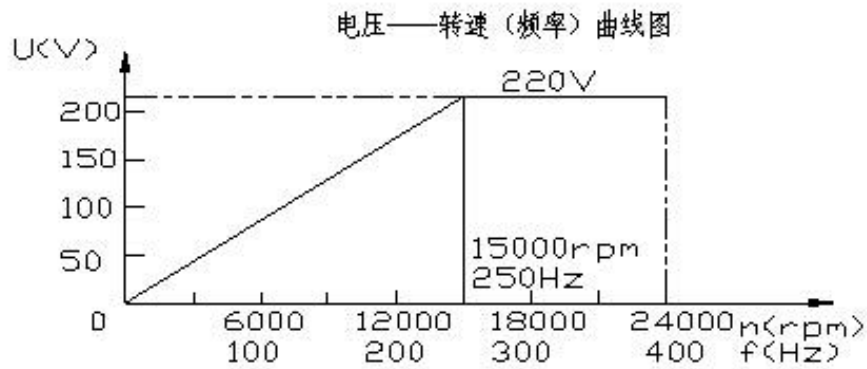

Voltage--speed (frequency) curve graph

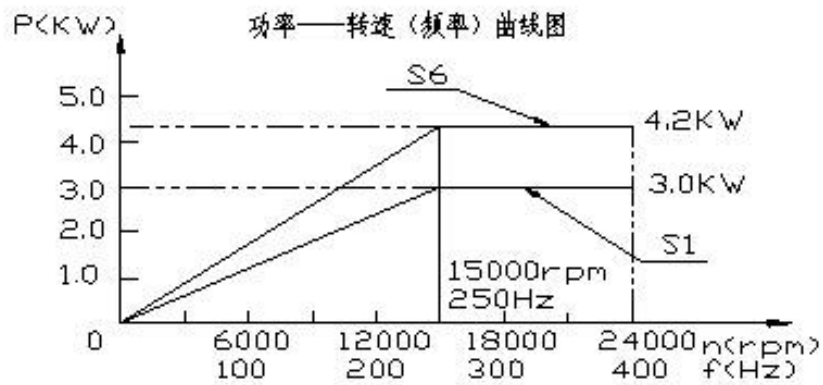

Power--speed (frequency) curve graph

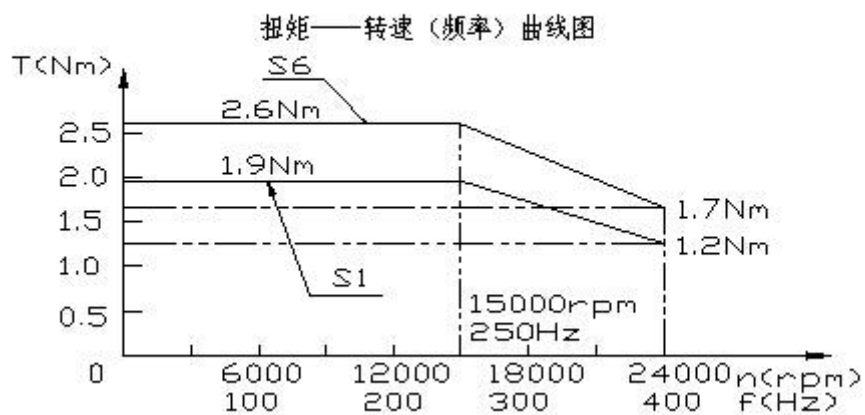

Torque-- speed (frequency) curve graph

4. Product technical parameter table

Spindle model:	RTM100-30-24Z/3.0	Voltage:	220V
Rated speed:	15000rpm	Maximum speed:	24000rpm
Rated frequency:	250Hz	Maximum frequency:	400Hz
Electric current:	7.6A	Motor pole:	2P
Rated power:	3.0KW (S1)	Peak power:	4.2KW (S6)
Rated torque:	1.9Nm	Peak torque:	2.6Nm

Technical parameters	
Spindle blowing dust/seal gas pressure (MPa)	0.2-0.25
Spindle gas seal gas flow (L/min)	65±10 (When on Working)
Cooling water pressure (MPa)	≧ 0.25
Cooling water flow (L/min)	≧ 2.5
Cooling water temperature(°C)	24-28
Spindle static state pulse (μm)	≧ 3
Spindle vibration (mm/s)	≧ 0.8
Spindle diameter (mm)	Φ100(0/-0.022)
Motor windings Pressure test (V/M)	1500V/1 minute withstanding Voltage test
Tool Interface	BT30
Inverter Specifications	3.7KW (220V)
Fitment	For castings, aluminum, glass, etc., and other processing

5. Spindle installation explanation

1) Circulating Cooling System Description

The system must ensure that the cooling water temperature of supply spindle is between 24-28°C. Usually setting the flow switch in return pipe of the cooling system, to ensure the supply of spindle cooling water. Cooling water requirements: we recommend using distilled water, while recommend Feinuokesi (Fenix) protective agent F1 (using the scale of 1: 200), coolant temperature is 26°C±2°C, inlet, outlet pipe temperature can't exceed 5 °C. It is allowed As long as other monitoring can ensure fuller spindle cooling.

2) Air sealing control

In order to prevent water or impurities enters internal of the spindle, spindle will have gas sealing device, the gas seal machine must be started start with the machine at the same time. And the need to go through multi-stage filtration.

3) Compressed gas quality requirements

The quality requirement of gas which is used in gas seals:

Oil content: < 0.01mg/m³

Solid particle: < 5μ m

Pressure dew point: < 7.5°C (0.7MPa)

4) Running-in program instructions

Only all monitoring issued no failures operational signals, at the same time, all safety devices have been installed and working properly, then allow start spindle.

Note: New or spindle which is not used for a long time must to be running slowly. First, start run spindle for half an hour as 25% of the maximum speed, then increase to 50% of the maximum speed, to run 15 minutes, finally, increase to maximum speed. It's need to check the temperature of the spindle during the whole process, spindle will get hot, but not hot hand, if the spindle becomes hot, pls stop the operation and contact our customer service department.

5) Product backend interface instructions

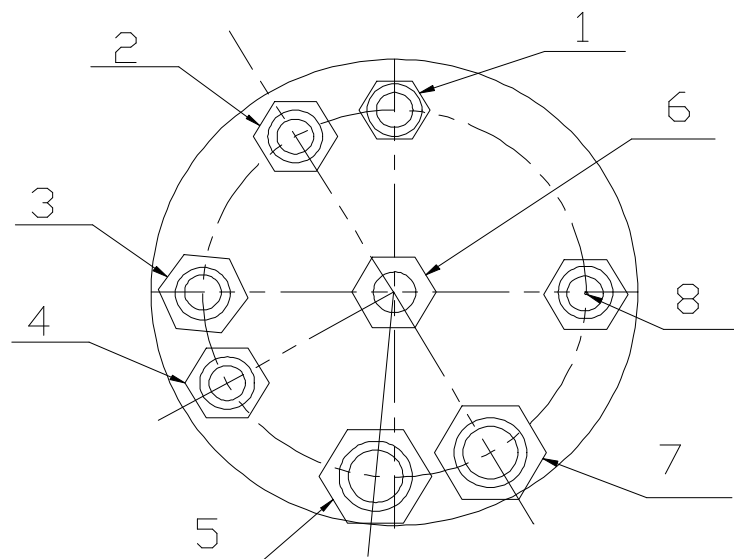

No.	Function	Definition
1	Gas sealing (Protection of impurities into the spindle 0.2-0.25MPa)	Φ8
2	Dust removal (Removing the shank and taper control impurity 0.3-0.4Mpa)	Φ8
3	Enter water (Spindle cooling)	Φ8
4	Return air (piston reset 0.35-0.45MPa)	Φ8
5	Power supply (Spindle power lines with thermistor)	U/V/W/ Ground wire
6	Intake air (Spindle loose knife 0.5-0.6MPa)	Φ8
7	Sensor (spindle tool change signals 24V)	Grip/Relax tool
8	Water out (spindle cooling)	Φ8

6) PTC140 Temperature coefficient thermistor parameters

Our products are equipped with a single thermistor PTC140, it can be used for spindle temperature protection.

Parameter name	Parameter symbol	Single core	Three core Series connection	Unit
Maximum DC working temperature	Umax	30	30	V
Rated control temperature	Tk	Designed according to user		°C
Rated control temperature tolerance	▲ T1	±5°C	±5°C	°C
Rated control temperature tolerance	▲ T2	±0.5°C	±0.5°C	°C
Resistance value on 25°C	R25	≤100	≤300	Ω
Rated control temperature on -5°C resistance value	Tk-5°C	≤550	≤1600	Ω
Rated control temperature on +5°C resistance value	Tk+5°C	≥1330	≥4000	Ω
Rated control temperature on +15°C resistance value	Tk+15°C	≥4	≥12	KΩ
Thermal response time	Ta	≤5	≤5	S
Dielectric strength	Uis	AC2.5	AC2.5	KV
Maximum control temperature	Tkmax	180	180	°C
Maximum allowable storage temperature	Tmax	180	180	°C
Minimum allowable storage temperature	Tmin	-40	-40	°C

7) Product Tool Change Signals Description

Sensor Model (0-24V, PNP), The spindle built two sensors.wiring Diagram is as follows:

1. Response broach knife signal, when the knife handle is hang, black sensor output signal;
2. Response loose knife signal, when the knife jaws open,black sensor output signal;

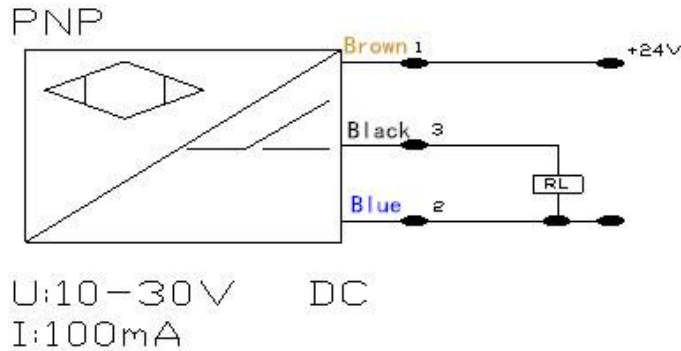

8) Product backend pneumatic description

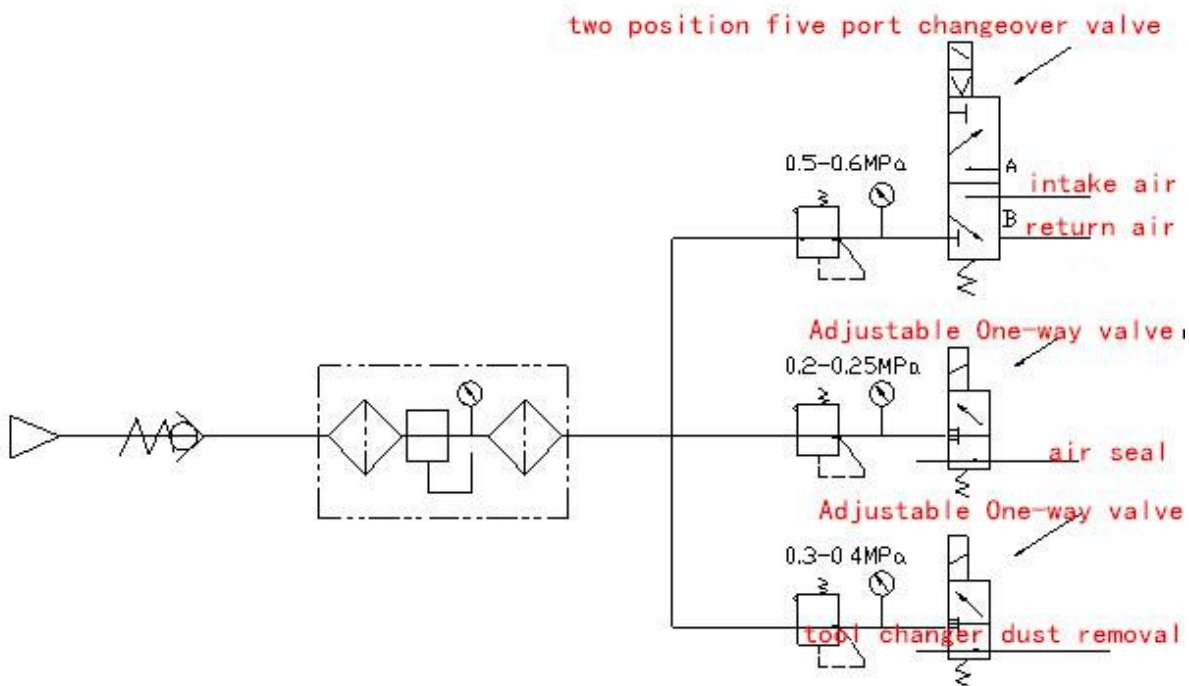
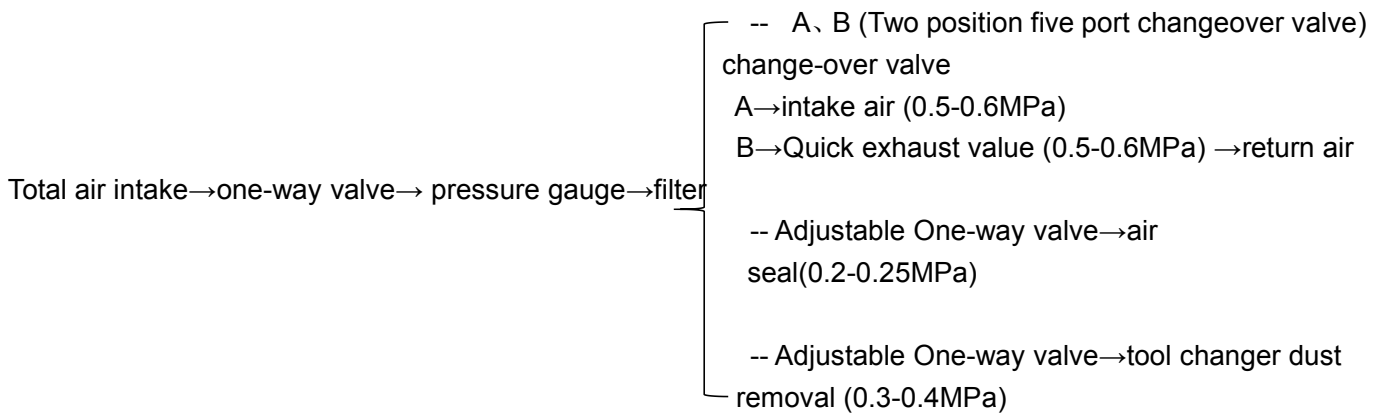

6. Products using precautions

Matters need attention when you install this spindle

- 1) Before installed, please read this manual carefully, then operate this spindle according to instructions requirements specification;
- 2) When installed, please carefully, pay attention to personal safety and to avoid injuries occurred during the installed process;
- 3) Suggest tool used by spindle compliance with IOS1940 specifications dynamic balance level within G1.0.
- 4) Do not use any tools tapping spindle;
- 5) Do not use sandpaper and grinding wheel to wipe or grind in axis core and taper hole;
- 6) Use special removal tool to remove the lock nut and the tool;
- 7) Untrained personnel can not disassemble and operate electric spindle;

Attention to maintenance and maintenance

- 1) Electric spindle storage temperature is $20\text{ }^{\circ}\text{C} \pm 10\text{ }^{\circ}\text{C}$, humidity $\leq 85\%$, to allow time to store up to three months;
- 2) Electric spindle most suitable ambient temperature is $20\text{ }^{\circ}\text{C} \pm 10\text{ }^{\circ}\text{C}$, bearing life can achieve the desired optimum value;
- 3) The power cord must take waterproof measure, electric spindle housing must be grounded;
- 4) Electro-spindle must not exceed nameplate parameters;
- 5) When electric spindle stop, should cut off the power, it must maintain a certain time after spindle completely stopped to wait spindle heat dissipation, then cut off the coolant, if you disable a long time, you need use compressed air, to remove the residual coolant liquid in the cooling pipe.
- 6) Not allowed to use any mechanical way to forced braking in the shaft;
- 7) After using the spindle every day, you should wipe spindle taper, then smear with rust oil;
- 8) Workplace must be clean, there should be strict dust control measures to prevent foreign matter enter the spindle.

7. Product common malfunctions&method of exclusion

Fault phenomenon	Reason	Method of exclusion
Electric spindle is not running after boot	1. No inverter power output or set incorrectly	Check that VFD supply three-phase output voltage and setting method
	2. Spindle plug is not inserted	Check the electrical spindle plug and connection.
	3. Bad plug connector	
	4. Bad stator line package	Replace line package
Shutdown after a few seconds of the boot	1. Electric spindle feed water bad insulation line package	Drying line package
	2. Electric spindle high temperature cause line package insulation damaged	Replace line package
	3. Electric spindle lose phase to run,then cause overcurrent protection blackout	Check the electric spindle connection
	4. Start time is too short	Increase the acceleration time
Electric spindle smoking or the housing hot after a few second of the boot	1. Inverter output voltage, frequency are not match the use of electric spindle voltage and frequency	Check the VFD and the spindle voltage, frequency
	2. The VFD is not set correctly	Reset the VFD
Locking nut loose when it is started	Wrong direction of rotation	Change the direction of rotation
Spindle have big noise and vibration	1. Bearing wear seriously	Replace the bearing
	2. Precision of parts damaged,it's effect dynamic balance	Calibration of dynamic balance
	3. Big beat of Spindle	Replace the spindle
Locking nut loose when it is stoped	Stop time is too short	Increase the deceleration time